



USER'S GUIDE
V: 582-01



HT362B

DVD Home Theater System

For the most up-to-date version of this User's Guide, go to www.gpx.com

Warnings and Precautions

- **CAUTION:** TO PREVENT ELECTRIC SHOCK, MATCH WIDE BLADE OF PLUG TO WIDE SLOT, FULLY INSERT.
- **WARNING:** To reduce the risk of fire or electric shock, do not expose this apparatus to rain or moisture.
- **AVERTISSEMENT:** Pour réduire le risque d'incendie ou de choc électrique, ne pas exposer cet appareil sous la pluie et l'humidité.
- **CAUTION:** Use of any controls or adjustments or performance of procedures other than those herein specified may result in hazardous radiation exposure.
- **WARNING:** Changes or modifications to this unit not expressly approved by the party responsible for compliance could void the user's authority to operate the equipment.
- **WARNING:** Do not place the unit on top of any soft, porous, or sensitive surfaces to avoid damaging the surface. Use a protective barrier between the unit and surface to protect the surface.
- **WARNING:** Use of this unit near fluorescent lighting may cause interference regarding use of the remote. If the unit is displaying erratic behavior move away from any fluorescent lighting, as it may be the cause.
- **CAUTION:** Danger of explosion if battery is incorrectly replaced. Replace only with the same or equivalent type.
- **PRÉCAUTION:** *Danger d'explosion si les piles sont remplacées de façon incorrect. Remplacer les piles seulement par le même type de pile ou l'équivalent.*
- **WARNING:** The battery, batteries, and battery pack shall not be exposed to excessive heat such as sunshine, fire, or the like.
- **WARNING:** Lithium batteries, like all rechargeable batteries are recyclable and should be recycled or disposed of in normal household waste. Contact your local government for disposal or recycling practices in your area. They should never be incinerated since they might explode.
- **WARNING:** Shock hazard - Do Not Open.
- **AVIS:** *RISQUE DE CHOC ÉLECTRIQUE - NE PAS OUVRIR*

WARNING: The remote control supplied with this product contains a button-cell battery that could be accidentally ingested by children. Do not leave button-cell batteries accessible to children. If swallowed, promptly see doctor and call (202) 625-3333.

Special note: When placing your unit on a lacquered or natural finish, protect your furniture with a cloth or other protective material.

Mains Plug or Direct plug-in adapter is used as disconnect device and it should remain readily operable during intended use. In order to disconnect the apparatus from the mains completely, the Mains Plug or Direct plug-in adapter should be disconnected from the mains socket outlet completely.

La fiche d'alimentation ou adaptateur de courant est utilisé comme dispositif de déconnexion et doit rester accessible pendant l'utilisation. Pour mettre l'appareil hors tension, la fiche ou adaptateur de courant doit être débranché de la prise de courant.

Do not mix old and new batteries.

Do not mix alkaline, standard (carbon-zinc), or rechargeable (ni-cad, ni-mh, etc) batteries.

No mezcle baterias viejas y nuevas.

No mezcle baterias alcalinas, estándar (carbono-zinc) o recargables (ni-cad, ni-mh, etc.).



WARNING: TO REDUCE THE RISK OF ELECTRIC SHOCK, DO NOT REMOVE COVER (OR BACK). NO USER-SERVICEABLE PARTS INSIDE. REFER SERVICING TO QUALIFIED SERVICE PERSONNEL.



The lightning flash with arrowhead symbol, within an equilateral triangle, is intended to alert the user to the presence of uninsulated "dangerous voltage" within the product's enclosure that may be of sufficient magnitude to constitute a risk of electric shock to persons.



The exclamation point within an equilateral triangle is intended to alert the user to the presence of important operating and maintenance (servicing) instructions in the literature accompanying the appliance.



This product utilizes a Class 1 laser to read Compact Discs. This Laser Compact Disc Player is equipped with safety switches to avoid exposure when the CD door is open and the safety interlocks are defeated. Invisible laser radiation is present when the CD Player's lid is open and the system's interlock has failed or been defeated. It is very important that you avoid direct exposure to the laser beam at all times. Please do not attempt to defeat or bypass the safety switches.



This symbol indicates that this product incorporates double insulation between hazardous mains voltage and user accessible parts.

This product incorporates copyright protection technology that is protected by U.S. patents and other intellectual property rights. Use of this copyright protection technology must be authorized by Rovi Corporation, and is intended for home and other limited viewing uses only unless otherwise authorized by Rovi Corporation. Reverse engineering and disassembly are prohibited.

Important Safety Instructions

1. Read these Instructions.
2. Keep these Instructions.
3. Heed all Warnings.
4. Follow all instructions.
5. Do not use this apparatus near water.
6. Clean only with a dry cloth.
7. Do not block any ventilation openings. Install in accordance with the manufacturer's instructions.
8. Do not install near any heat sources such as radiators, heat registers, stoves, or other apparatus (including amplifiers) that produce heat.
9. Do not defeat the safety purpose of the polarized or grounding - type plug. A polarized plug has two blades with one wider than the other. A grounding type plug has two blades and a third grounding prong. The wide blade or the third prong are provided for your safety. When the provided plug does not fit into your outlet, consult an electrician for replacement of the obsolete outlet.
10. Protect the power cord from being walked on or pinched particularly at plugs, convenience receptacles, and the point where they exit from the apparatus.
11. Only use attachments/accessories specified by the manufacturer.



Use only with a cart, stand, tripod, bracket, or table specified by the manufacturer, or sold with the apparatus. When a cart is used, use caution when moving the cart/apparatus combination to avoid injury from tip-over.

12. Unplug this apparatus during lightning storms or when unused for long periods of time.
13. Refer all servicing to qualified service personnel. Servicing is required when the apparatus has been damaged in any way, such as power-supply cord or plug is damaged, liquid has been spilled or objects have fallen into the apparatus, the apparatus has been exposed to rain or moisture, does not operate normally, or has been dropped.
14. Unplug the apparatus during lightning storms or when unused for long periods of time.
15. CAUTION: These servicing instructions are for use by qualified service personnel only. To reduce the risk of electric shock, do not perform any servicing other than that contained in the operating instructions unless you are qualified to do so.
16. Do not install this equipment in a confined or building-in space such as a book case or similar unit, and remain a well ventilation conditions at open site. The ventilation should not be impeded by covering the ventilation openings with items such as newspaper, table-cloths, curtains etc
17. WARNING: Only use attachments/accessories specified or provided by the manufacturer (such as the exclusive supply adapter, battery etc).
18. When not in use and during movement, please take care of the power cordset, e.g. tie up the power cordset with cable tie or something like that. It shall be free from sharp edges and the like that can cause abrasion of the power cordset. When put into use again, please make sure the power cordset being not damaged, If any damages found, please look for the service person to replace the power cordset specified by the manufacturer or have the same characteristics as the original one.
19.  Invisible laser radiation when open and interlocks defeated. Avoid exposure to beam of laser.
20. Attention should be drawn to environmental aspects of battery disposal.
21. Use of the apparatus in moderate climates.

FCC Warnings

WARNING: Changes or modifications to this unit not expressly approved by the party responsible for compliance could void the user's authority to operate the equipment.

NOTE: This equipment has been tested and found to comply with the limits for a Class B digital device, pursuant to Part 15 of the FCC Rules. These limits are designed to provide reasonable protection against harmful interference in a residential installation. This equipment generates, uses, and can radiate radio frequency energy and, if not installed and used in accordance with the instructions, may cause harmful interference to radio communications. However, there is no guarantee that interference will not occur in a particular installation. If this equipment does cause harmful interference to radio or television reception, which can be determined by turning the equipment off and on, the user is encouraged to try to correct the interference by one or more of the following measures:

- Reorient or relocate the receiving antenna.
- Increase the separation between the equipment and receiver.
- Connect the equipment into an outlet on a circuit different from that to which the receiver is connected.
- Consult the dealer or an experienced radio/TV technician for help.

Additional Warnings

- The apparatus shall not be exposed to dripping or splashing and that no objects filled with liquids, such as vases, shall be placed on apparatus.
L'appareil ne doit pas être exposé aux écoulements ou aux éclaboussures et aucun objet ne contenant de liquide, tel qu'un vase, ne doit être placé sur l'objet.
- Battery shall not be exposed to excessive heat such as sunshine, fire or the like.
Les piles ne doivent pas être exposées à de forte chaleur, tel qu'à la lumière du soleil, au feu ou autres choses de semblable.
- Caution marking is located at the rear or bottom of the apparatus.
Attention marquage est situé sur le panneau arrière ou inférieur de l'unité.
- The marking information is located at the rear or bottom of apparatus.
Le marquage est situé sur le panneau arrière ou inférieur de l'unité.

DVD Player

Features

- DVD player: DVD, DVD±R/RW
- CD player: CD, CD-R/RW, MP3 CD, JPEG CD
- 5.1 channel surround sound
- Aspect ratio: 16:9, 4.3LB
- Progressive scan
- Multi-language on-screen display
- Drawer-load disc player
- NTSC/PAL video system
- Enhanced audio quality
- 6 surround speakers: subwoofer, front left & right, rear left & right and center
- Digital volume control
- AM/FM Radio (PLL)
- Station memory presets (20 FM, 20 AM)
- Component video output
- S-video output
- Composite video output
- Optical digital audio output
- Coaxial digital audio output
- RCA stereo audio inputs
- RCA stereo audio outputs
- FM antenna input
- AM antenna input
- Amber LED display
- Full-function remote
- Wall mountable speakers
- Cloth speaker grill
- Dual Voltage: 220V/50Hz, 120V/60Hz
- AC power: built-in AC power cable

Included

- Remote control: requires 2 AAA batteries (included)
- RCA audio/video cable
- Speaker cables
- FM wire antenna
- AM loop antenna

Table of Contents

DVD Player	4
Features	
Included	
Table of Contents	5
Introduction	6
Setup	8
Power	
Remote	
Speaker Setup	9
Suggested Speaker and Subwoofer Layout	
Speakers	10
Connecting the Speakers	
Connecting the Video Outputs to a Television	11
Composite Video Output (Good)	
S-Video Output (Better)	
Component Video Output (Best)	
Connecting the Audio Outputs	12
RCA Stereo Audio Output (Good)	
Coaxial Digital Audio Output (Better)	
Optical Audio Output (Best)	
DVD	13
Loading a Disc	
Playing a Loaded Disc	
Programming a Loaded Disc	
Playing a JPEG CD	
Accessing the DVD Setup Menu	
Radio	14
Tuning the AM or FM Radio	
Saving an AM/FM Radio Station	
Tuning to a Preset Station	
RCA Audio Inputs	15
Using the RCA Audio Inputs	
Company Information	16
International Support	
Contact Information	
Warranty	

Introduction

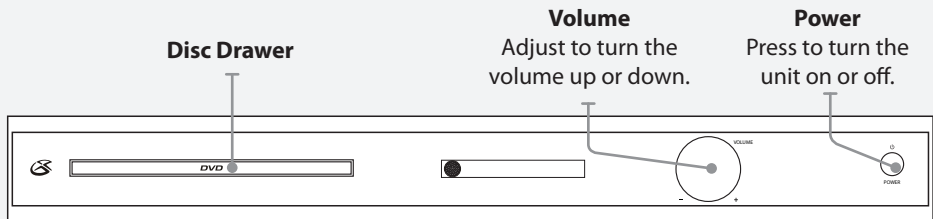
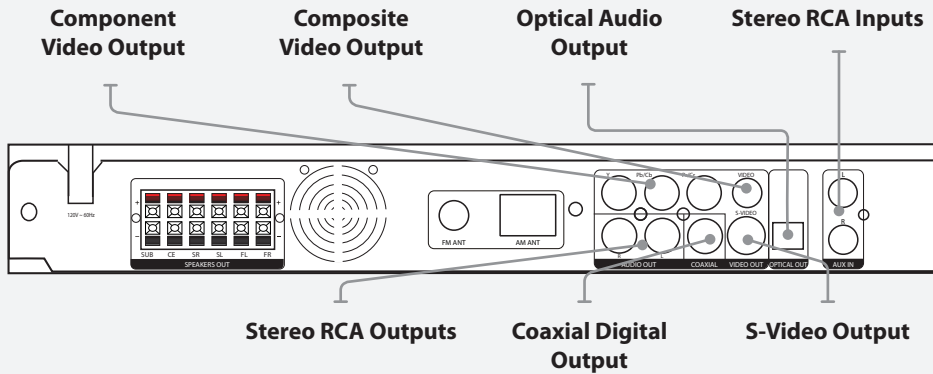
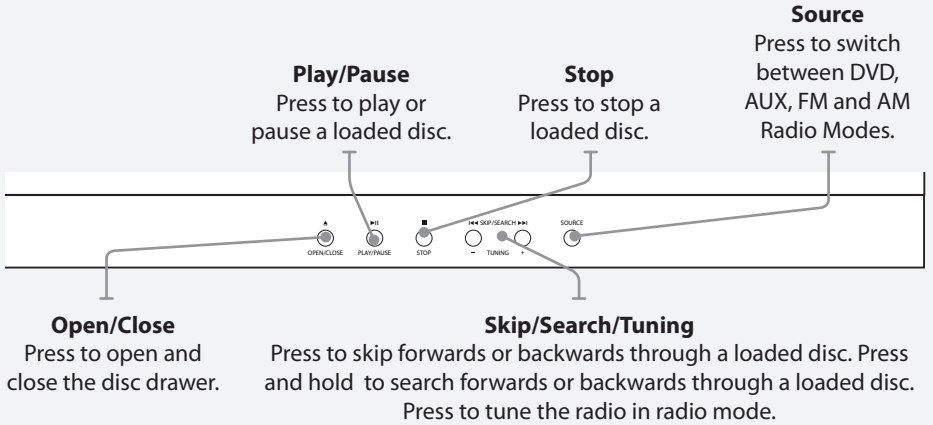

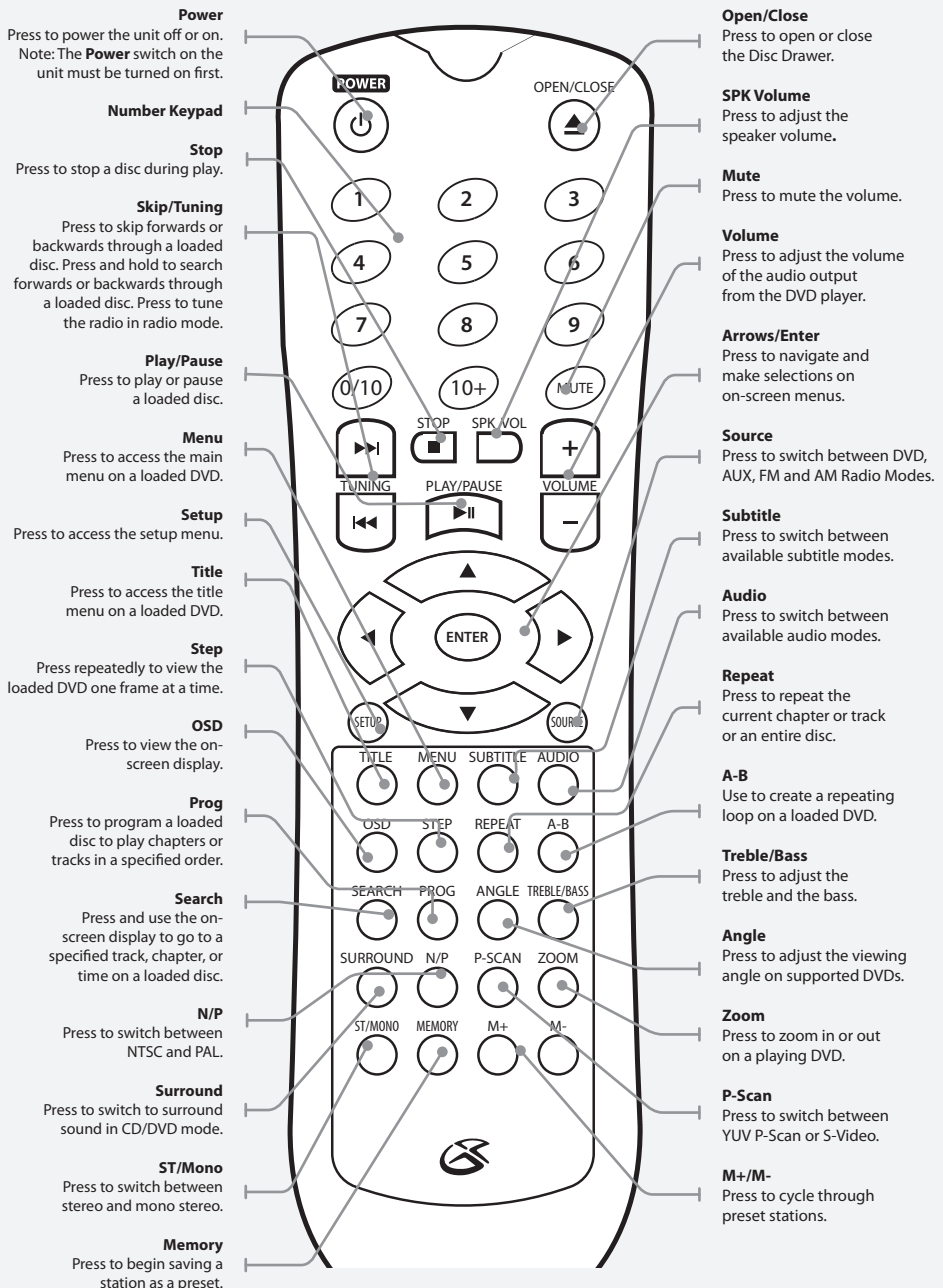

Setup

Power

AC power: AC power cable attached

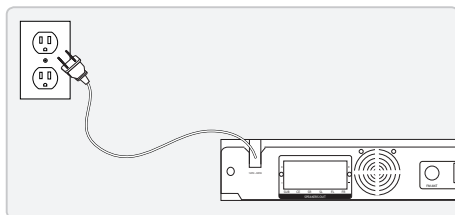

Remote

Requires 2 AAA batteries (included)

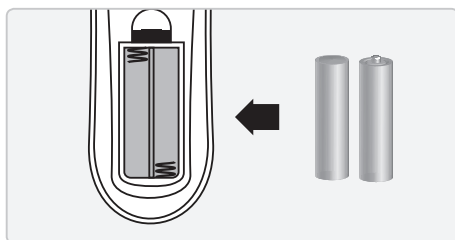

Speaker Setup

Suggested Speaker and Subwoofer Layout

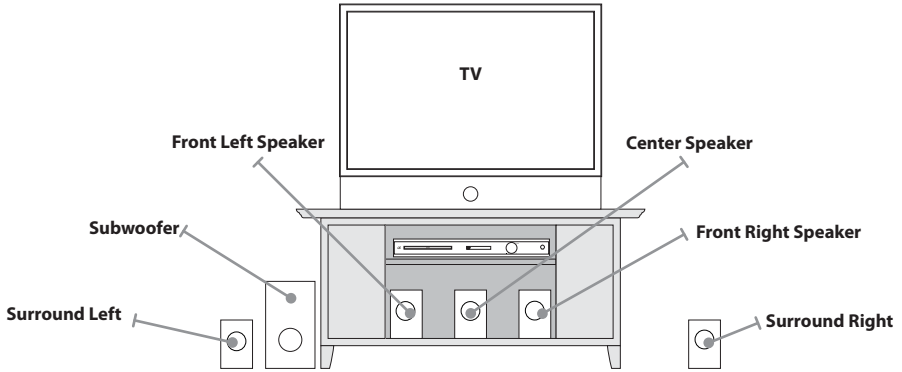

Speakers

Connecting the Speakers

1. Press the lever down firmly.
2. Insert the corresponding colored bare wire into the center of the hole, making sure none of the insulation is touching, and release the lever.

Note: The negative wires are marked by a stripe on the insulation, please be sure to put the negative and positive wires into their corresponding holes.

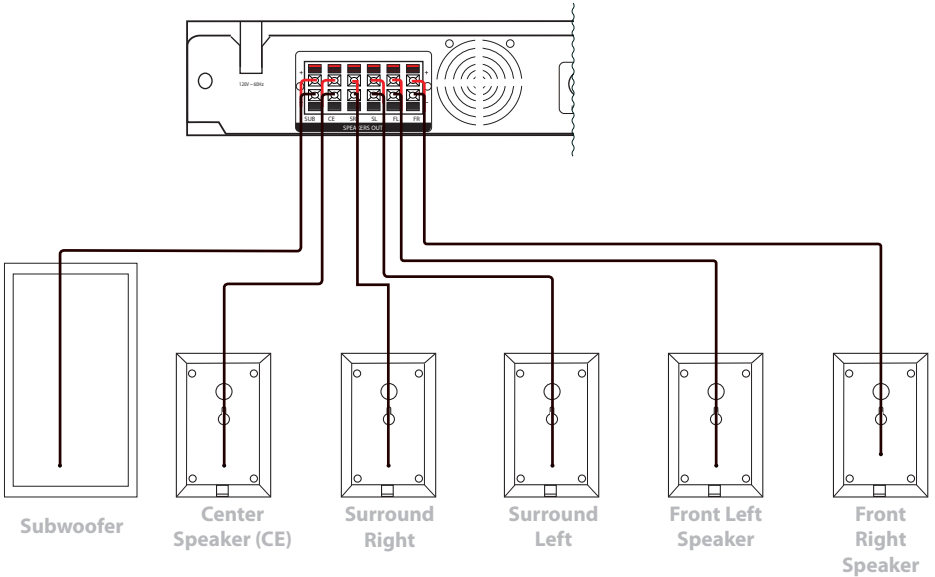
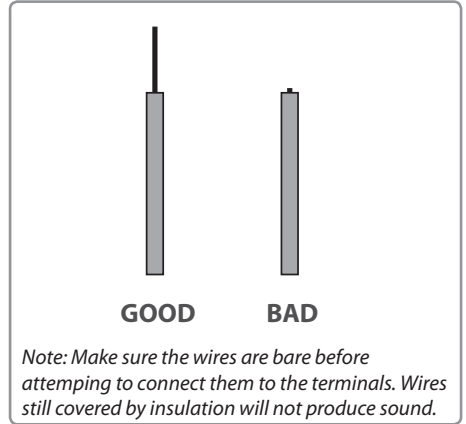

Connecting the Audio Outputs

RCA Stereo Audio Output (Good)

Use the **Rca Stereo Audio Output** to send audio from the DVD player to a television.

Requires an RCA audio cable (included).

1. Use the RCA audio cable to connect the **Rca Stereo Audio Output** to an RCA stereo audio input on a television.
2. Adjust the connected television's input setting to match the input used in the previous step.

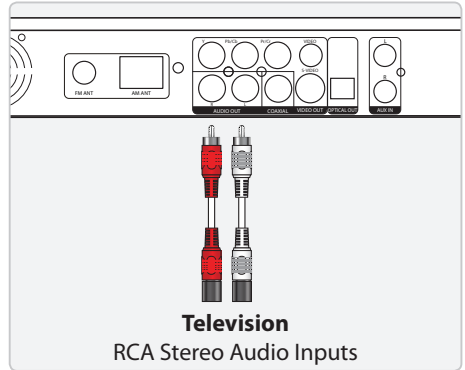

Coaxial Digital Audio Output (Better)

Use the **Coaxial Digital Audio Output** to send high quality audio from the DVD player to an audio system.

Requires a Coaxial Digital Audio cable (not included).

1. Use the Coaxial Digital Audio cable to connect the **Coaxial Digital Audio Output** to a coaxial digital audio input on an audio system.
2. Adjust the connected audio system's input setting to match the input used in the previous step.

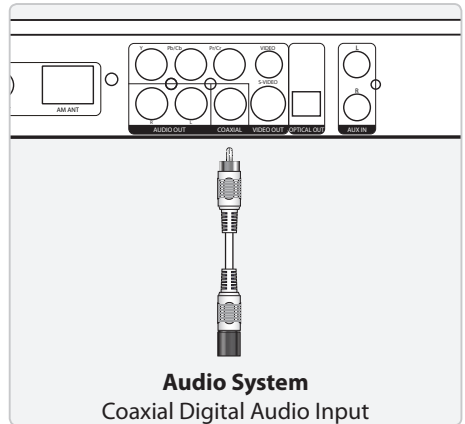

Optical Audio Output (Best)

Use the **Optical Audio Output** to send high quality audio from the DVD player to an audio system.

Requires a Optical Audio cable (not included).

1. Use the Optical Audio cable to connect the **Optical Audio Output** to an Optical Audio input on an audio system.
2. Adjust the connected audio system's input setting to match the input used in the previous step.

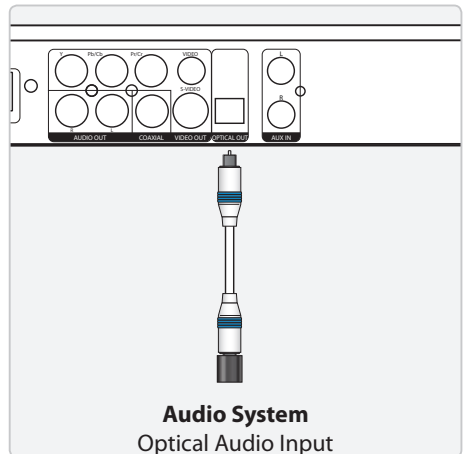

DVD

Loading a Disc

1. Press the **Source** button to switch to DVD mode.
2. Press the **Open/Close** button to open the **Disc Drawer**.
3. Load a disc into the DVD player, label side facing up.
4. Press the **Open/Close** button to close the **Disc Drawer**.

After a disc is loaded, it will begin playing automatically.

Playing a Loaded Disc

1. Follow the instructions for [Loading a Disc](#).
2. If the disc does not begin playing automatically, press the **Play/Pause** button.

Programming a Loaded Disc

1. Follow the instructions for [Loading a Disc](#) and [Playing a Loaded Disc](#).
2. While the loaded disc is playing, press the **Prog** button on the remote.
3. Use the **Arrows/Numeric** buttons to highlight and select a DVD title and chapter, or CD track.

DVD Titles and chapters or CD tracks will play in the order they are programmed.

4. Repeat step 3 until the desired DVD titles and chapters or CD tracks are programmed.
5. Highlight the on screen "PLAY" icon to play.
6. Highlight the on screen "Clear" icon to clear the program.

Playing a JPEG CD

1. Load a JPEG photo disc into the player by following the instructions for [Loading a Disc](#).
A slide show of JPEG photos from the CD will begin playing automatically.
2. Press the **Stop** button to access a file view of the loaded JPEG disc.
3. Use the **Arrows/Enter** buttons on the remote to select and view photos.

Accessing the DVD Setup Menu

1. Press the **Setup** button on the remote to access the home theater system's setup menu.

Radio

Tuning the AM or FM Radio

1. Press the **Power** button to turn the unit on.
2. Press the **Source** button to switch to **FM or AM Radio** mode.
3. Press the **Tuning +/-** buttons to tune the FM or AM radio.
4. Press the **ST/Mono** button on the remote to switch between stereo and mono mode.

Saving an AM/FM Radio Station

1. Follow the instructions for Tuning the AM or FM Radio.
2. Press the **Tuning +/-** buttons to tune the FM or AM radio.
3. Press the **Memory** button.
4. Press the **Numeric** buttons to select the desired station.
5. Press the **Memory** to save the current radio station to the currently selected memory slot.

The display will show "Save Ok"

Up to 20 AM and 20 FM stations can be saved at one time.

Tuning to a Preset Station

1. Follow the instructions for Tuning the AM or FM Radio and Saving an AM/FM Radio Station.
2. Press the **M+** or **M-** buttons to cycle through saved radio stations.

RCA Audio Inputs

Using the RCA Audio Inputs

Requires a 3.5mm to RCA audio cable (not included).

1. Connect a 3.5mm to RCA audio cable into the RCA audio inputs on the speaker system and into an audio output on an MP3 player or other audio source.
2. Press the **Source** button to switch to AUX mode.
3. Use the native controls on the connected audio source to play, pause, and control audio.

Company Information

International Support

To download this User's Guide in English, Spanish, or French, or to get answers to frequently asked questions, visit the support section at www.gpx.com.

Para descargar este Manual del Usuario en inglés, español y francés, o para obtener respuestas a preguntas frecuentes, visite la sección de apoyo en www.gpx.com.

Pour télécharger ce guide de l'utilisateur en anglais, espagnol ou français, ou pour obtenir des réponses à des questions fréquemment posées, consultez la rubrique d'assistance sur www.gpx.com.

Contact Information

Email Support: prodinfo@dpiinc.com

Email Parts: partsinfo@dpiinc.com

Phone Support: 1-888-999-4215

Website: www.gpx.com

Warranty

For Warranty Information and the most up-to-date version of this User's Guide, go to: www.gpx.com